

U S E R M A N U A L

Version: 02

TABLE OF CONTENTS

1. GENERAL INFORMATION 4

1.1. Warranty Information: 4

1.2. Technical Service:..... 4

1.3. Disposal Instruction: 4

1.4. Contacts: 4

2. GENERAL SAFETY WARNINGS 5

2.1. Danger - Warnings Symbols: 5

2.2. Use of the Instrument: 6

3. INTRODUCTION 7

3.1. Description: 7

3.2. Salient Features: 7

3.3. Technical Specifications - URICHA 8

4. PACKING, TRANSPORT AND STORAGE 9

4.1. General Warnings: 9

4.2. Packing: 9

4.3. Instrument Transportation: 9

4.4. Storage of the Instrument: 9

5. INSTRUMENT DESCRIPTION 10

5.1. Perspective View: 10

5.2. Instrument Working Principle: 12

5.2.1. Block Diagram 12

5.3. Functional Principle: 12

6. INSTALLATION AND START-UP INSTRUCTIONS 13

6.1. Unpacking Instructions: 13

6.1.1. Packing List 13

6.2. Placing the Instrument: 13

6.3. Power Supply 14

6.4. Protective Grounding 14

6.5. Start-up Instructions: 14

7. FLOW CHART REPRESENTATION 16

8. START UP SCREEN 17

8.1 Test 17

8.2. Diagnostics 24

8.2.1. Lamp Amplitude 25

8.2.2. Printer Test 26

8.2.3. Motor Test 28

8.2.4. Clear Memory 28

8.3. Utilities 29

8.3.1 Auto Start (ON/OFF) 29

8.3.2. Clinic Details 29

8.3.3. Comm. Mode : USB / Serial 30

13. SAFETY CLEARANCE CERTIFICATE:

Please complete all information requests on this form prior to returning the instrument to the manufacturer or your local distributor for servicing, repairs or return. Thank you for your co-operation.

Customer _____ Contact _____

Address _____ Position _____

_____ Dept. _____

_____ Tel: _____

Country _____ Fax: _____

Post Code _____

Model No. _____ Serial No. _____

Accessories Returned _____

Date of Purchase (if known) _____

Complaint _____

Has the equipment been exposed to any of the following:(*delete as applicable)

a) Blood, body fluids, pathological specimens *YES/NO

If YES, please specify _____

b) Other Biohazard *YES/NO

if YES, Please specify _____

12. DECONTAMINATION

- 12.1. Decontamination Procedure:
If the instrument is to be shipped after being exposed to potentially hazardous material, it should be decontaminated. The following procedure outlines how to decontaminate the instrument before packaging and shipment.
- 12.2. Purpose of Decontamination:
Decontamination minimizes the risk to all who come in contact with the instrument during shipping, handling, and servicing.
- 12.3. General Considerations:
- Any laboratory instrument that has been used for clinical analysis is considered a biohazard and should be decontaminated prior to handling. Intact skin is generally considered an effective barrier against infectious Organisms; however, small abrasions and cuts may not be always visible. Prophylactic gloves must be worn when handling instruments that have not been decontaminated. Gloved hands should be considered contaminated at all times and must be kept away from eyes, mouth and nose at all times.
 - Mucous membranes are considered prime entry routes for infectious agents. Wear eye protection and a surgical mask when there is a possibility of aerosols.
 - Eating and drinking while decontaminating instruments is not advisable.
- 12.4. Procedure:
- A solution of .5% Sodium Hypo Chlorite (NaOCL) solution (Bleach) is used. Commercial bleach is 5% NaOCL; household bleach is 3% NaOCL. When using commercial bleach, use a 10:1 mixture; if using household bleach, a 6:1 mixture is required. This is a caustic solution. It is important to wear gloves and eye protection when handling it.
 - Wipe down the carrier and all exposed surfaces of the unit with the bleach solution. Remove the top shroud of the instrument and wipe down the top surface of the instrument base, as well as the inside of the top shroud.
 - Reassemble the unit and discard the used gloves and towels.

8.3.4. Printer: ON/OFF.....	30
8.3.5. Date Time	30
8.4. Data Transfer	31
8.4.1. Data Transfer Through USB	31
8.4.2. Data Transfer Through Serial Cable.....	32
8.5. Data	32
8.5.1. Result	33
8.5.1.1. List Result	33
8.5.1.2. Search By PID	34
9. PRECAUTIONS	35
10. TROUBLESHOOTING	36
11. CLEANING AND MAINTENANCE	37
11.1. Danger of Infection:	37
11.2. Cleaning:	37
11.2.1. How to clean the Housing	37
11.2.2. How to clean the Strip Holder.....	37
12. DECONTAMINATION	38
12.1. Decontamination Procedure	38
12.2. Purpose of Decontamination	38
12.3. General Considerations	38
12.4. Procedure:	38
13. SAFETY CLEARANCE CERTIFICATE	39

1. GENERAL INFORMATION

1.1. Warranty Information:

Each Instrument is completely tested and guaranteed for twelve months from delivery. The warranty applies to all the mechanical and electrical parts. It is valid only for proper installation, use, and maintenance in compliance with the instructions given in this manual.

ROBONIK will at its discretion repair or replace parts, which may be found defective in the warranty period. The warranty does not include any responsibility for direct or indirect personal and material damages, caused by improper use or maintenance of the instrument.

Parts that are inherently subject to deterioration are excluded from the warranty. In case of defects due to misuse of the instrument, any travel and man-hour expenses will be charged extra.

1.2. Technical Service:

ROBONIK is always accessible to the customers for any kind of information about installation, use, maintenance, etc. When asking for service, please refer to this manual, and report the data reported on the identification label (serial number).

Only qualified technicians are entitled to fix the instrument; the user, as described in this manual, should carry out ordinary maintenance.

ROBONIK technical service or an authorized service center with specialized technicians, with suitable instrumentation and original spare parts only are always available for extraordinary maintenance (repair), under a yearly maintenance contract or on specific demand.

1.3. Disposal Instruction:

In case of removal or disposal of instrument, following instructions need to be followed

- Do not dispose in municipal waste; follow local regulations for instrument disposal.
- Plastic Parts, Electronic PCB's and components can be recycled, so return it back the instrument to manufacturer.

1.4. Contacts:

<p>Manufacturer: ROBONIK (INDIA) PVT LTD A-374, TTC, MIDC Industrial Area, MAHAPE, NAVI MUMBAI -400710 INDIA</p> <p>Tel: +91-22-67829700, Fax: +91-22-67829701</p> <p>Email: sales@robonikindia.com Website: www.robonik.in</p>

11. CLEANING AND MAINTENANCE

11.1. Danger of Infection:

Urine and used test sticks bare the danger of infection. Always use protective gloves during handling and disposal. The disposal of used test sticks should be Performed according to the regulations for the handling of potentially infectious material.

11.2. Cleaning:

11.2.1. How to Clean the Housing

The instrument housing may be wiped with a cloth. Mild cleaning agents or disinfectants may be used. Ensure that no moisture permeates the equipment.

11.2.2. How to clean the Strip Holder

Wipe off Urine residues from the strip holder with a lint-free cloth after each measurement. This prevents crustification and drying of Urine residues.

The strip holder can be removed from its mechanism and should be cleaned with water and when necessary with cleaning agent or disinfectant. Make sure that the instrument is turned off before removing the strip holder.

After cleaning the strip holder should be put back on to its mechanism carefully. The circular notch of mechanism and strip holder must be placed on top of each other.

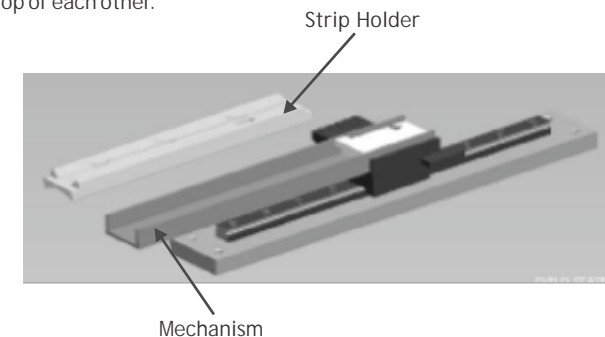

10. TROUBLE SHOOTING

ERROR MESSAGES	CAUSES	CORRECTIVE ACTION
"MEMORY FULL RECORD IN SEQ. DELETE"	If Number of saved records exceeds the memory limit. Before running the next test this message will displayed	Delete records and then run strip. If not deleted next tests will be overwritten on earlier records in sequence.
"Please Enter Batch Info."	This is an initial message after selecting "Test" option for entering the sample details.	Select "Batch Info" for entering the sample details.
"STRIP ABSENT"	Test strip is not placed in the strip holder.	Place the Test strip in the Strip holder.
"REMOVE STRIP"	If the previous strip is not removed from the Strip holder.	Remove the test strip from the Strip holder.
"Please Save Sample Details"	Suppose after entering all the Sample Details, if user selects "RUN" option without saving the parameters, then it will display the message string "Please Save Sample Details"	Therefore, after entering the sample details one must save the test parameters & then select the "RUN" option.
"Batch Full"	Batch means bunch of samples & max. Samples per batch is 25. User can enter maximum 25 samples in each batch. If you try to add more samples then it will display the message string - "BATCH FULL".	Do not enter sample details more than 25 in a single batch.
"Batch Empty"	"BATCH EMPTY" is displayed when the batch is empty without any sample details.	Enter the sample details before running the samples.
"Connect USB cable"	Using data receiving application on computer, If you have not connected the data cable (i.e. USB cable) correctly, you will get this message.	To avoid this message, connect proper data cable, select the same communication medium (ie.USB), on computer data receiving application, which you have selected on instrument 'Communication Setting'.
"Wait for Start command"	This command appears for selecting "Start Logging" button in the Application screen.	Select "Start Logging" button in the Application screen.
"Paper Error"	If paper is not loaded in the printer.	Load the paper in the printer.
"Flap Error"	If Printer flap is not closed.	Close the Printer flap before giving any Print command.
"PAPER ERROR OR FLAP ERROR"	If Printer flap not closed and paper not loaded.	Keep printer flap properly closed or load the paper REFER "Thermal printer".
"No Records Found"	Invalid PID Entry while searching the Test Results wrt Patient's Identity.	Avoid entering Invalid PID while searching the Test Results.

2. GENERAL SAFETY WARNINGS

2.1. Danger - Warnings Symbols:

The following symbols are used to inform the user of the safety rules.



This symbol indicates Direct current.



This symbol indicates that mains switch of instrument is ON.



This symbol indicates that mains switch of instrument is OFF.



This symbol indicates generic danger. It means that, serious damage can occur to the operator if described precautions are not observed.



This symbol indicates HIGH ELECTRIC VOLTAGE. It is dangerous to touch any part having this label. Only qualified operators can access these components, after unplugging the instrument from the Supply.



This symbol indicates that the instrument involves the handling of samples, which can be infected (urine or human serum). In this condition, infection or contamination might occur. Pay attention to the general safety warnings when in presence of such biological substances. Use Protective clothes, gloves and glasses.



This symbol in the user manual indicates that damages to the instrument or erroneous results could occur if the given warnings are not followed.



This symbol indicates a portion, which is particularly important, and should be studied carefully.



This symbol indicates a Protective Earth or Ground terminal.

General Symbols



Symbol for "Manufacturer"



Symbol for " IN VITRO DIAGNOSTIC MEDICAL DEVICE"

2.2. Use of the Instrument:

The instrument has to be used for the designed purposes under specified conditions, following proper procedures and safety rules to be followed by qualified personnel.

THIS MANUAL CONTAINS INSTRUCTIONS FOR OPERATION BY QUALIFIED PERSONNEL ONLY.

- ❖ A qualified user has to make sure that the environmental condition is suitable, the installation is correct, the use and maintenance are proper, according to the general safety rules as well as to the particular precautions described in the manual (However, the user is not entitled to repair the instrument).
- ❖ A qualified technician is entitled to maintain and fix the instrument, according to the instructions given, using the original spare parts.
- ❖ Maintain room temperature and humidity as specified in the manual.
- ❖ The instrument has to be used as described in this manual. If it is not used with the protection provided by the instrument, it may be impaired.
- ❖ *Alterations to the instrument are strictly prohibited. The user is liable and solely responsible for any improper modification to the instrument, and for the consequences derived as a result.*
- ❖ If the instrument needs extraordinary maintenance, contact ROBONIK service or an authorized service center. Specialized technicians, who will be able to repair the instrument using original spare parts, will carry out the maintenance.
- ❖ This IVD equipment complies with the emission and immunity requirements as per IEC61326 series.



Warning: This equipment has been designed and tested to CISPR11 Class A. In a domestic environment it may cause radio interference, in which case, you may need to take measures to mitigate the interference."

- ❖ An advisory that the electromagnetic environment should be evaluated prior to operation of the device.



Warning: Do not use this device in close proximity to sources of strong electromagnetic radiation (e.g. unshielded international RF sources), as these may interfere with the proper operation.

9. PRECAUTIONS

Precautions:

- ❖ Keep the place dry and clean.
- ❖ Use original packaging for transportation.
- ❖ Refer to the instructions provided by reagent manufacturer.
- ❖ If the display shows error messages instead of a result, then please read the chapter 10 and repeat the measurement.
- ❖ Make sure to remove excess urine by blotting the test strip carefully on a lint-free cotton cloth.

User can take the printout of the Result by selecting 'Print' option present on the screen. 'ESC' option will help the user to come out of the screen to the Result screen. But if the Printer is set to its disabled mode then on selecting Print option it will display the following screen which will ask the user whether to Enable or Disable the Printer.

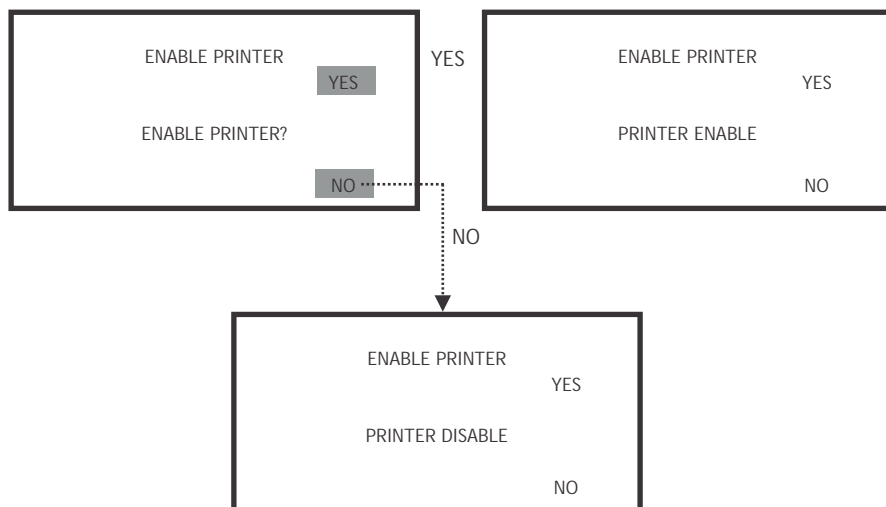

8.5.1.2. Search by PID

Select "Search by PID", it will display alphanumeric screen through which user can enter the PID. This option helps the user to search the test with the help of patient's identity. But if we enter wrong PID then it will display the message "NO RECORD FOUND" in the next screen.

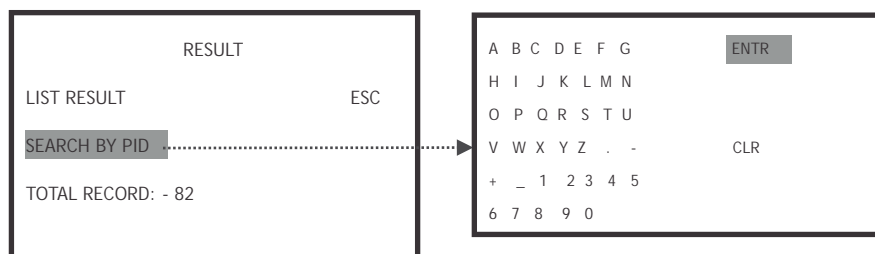

3. INTRODUCTION

3.1. Description:

URICHA is a reflection photometer for the analysis of urine test sticks. The measurements are performed under standardized conditions; measured values will display, printed and can be transferred to a computer. The URICHA is designed for in-vitro DIAGNOSTICS use (IVD) and should be used by Qualified and healthcare professionals, only.

3.2. Salient Features:

Urine Chemistry analyzer is an easy to use low power Urine analyzer designed for field use with following salient features.

- Easy to use, handheld low power analyzer.
- Finger touch operation makes easy to interface.
- Large memory to save 250 Results with date.
- Convenient computer interface via USB to back up the results.
- Single input voltage 12 VDC.
- Large display for clear view.
- Results for all 10 parameters are conveniently displayed on one page.
- Alphanumeric Input possible
- Instrument can be connected to Laboratory information systems and also to PC using USB/RS232 interfaces & software.
- Built in thermal printer with 24 characters.

3.3. Technical Specifications - URICHA

Technical Specification Parameters	Values
Test Samples	Urine
Measurement Principle	Reflectance photometry
Optical Measurement	RGB Sensor
Test Strip	Strips - 10
Light Source	LED
Display	320 X 240 dots TFT color display View area 73.1 mm x 55.6 mm
Printer	Built in Thermal Printer
Result Storage Memory	Approx. 250 results with date
Test Parameters	BLD, UBG, BIL, PRO, NIT, KET, GLU, PH, SG & LEU
External Output	USB, RS232 Interface to computer
Adaptor Specification	Input: 100 - 240V, 50-60 Hz, 0.5A (min) Output: 12V DC, 1.5A (min) 3 Pin Adapter with Earthing
Power Wattage	18 Watts (minimum)
Operating Position	On horizontal flat, rigid & vibration free surface
Operating Conditions Temperature Relative Humidity	From +18 ° C to 35° C up to 85%
Storage Conditions Temperature Relative Humidity	From -10° C to 50° C up to 85%
Enclosure	ABS Plastic
Size (mm) (L X B X H)	235 x 170 x 130
Weight	1.40 Kg

8.5.1. Result

To view the result of the test run, select RESULT option.

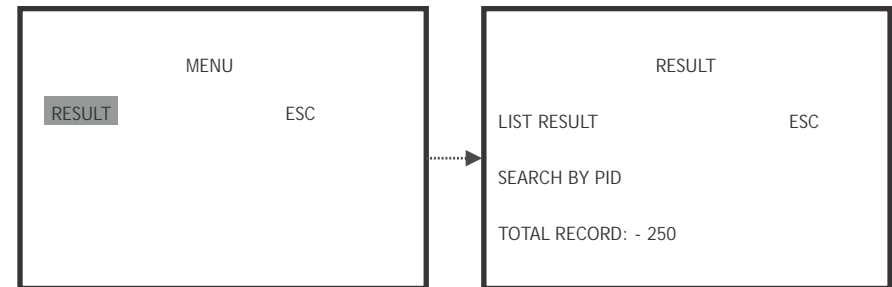

8.5.1.1. List Result

"List Result" will display the following screen which consists of Sr. no., PID (if any), date along with ESC, SEL, NEXT and PREV options.

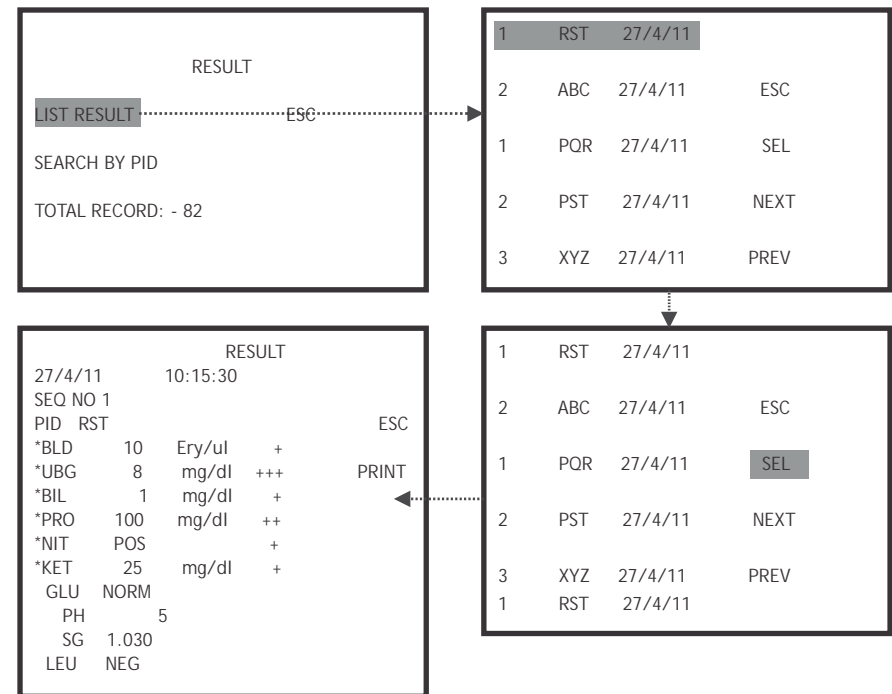

8.4.2. Data Transfer through Serial cable

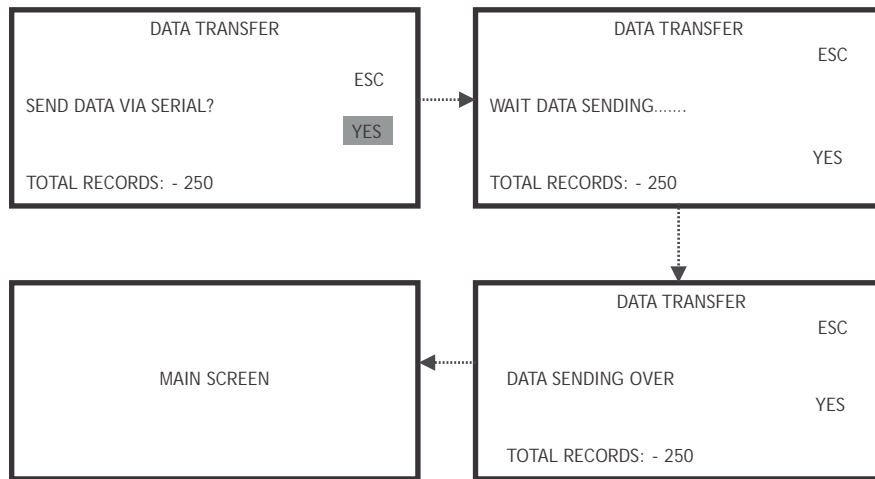

8.5. Data

Select "DATA" option present on the main menu screen. It will display the screen consisting of Result and ESC options.

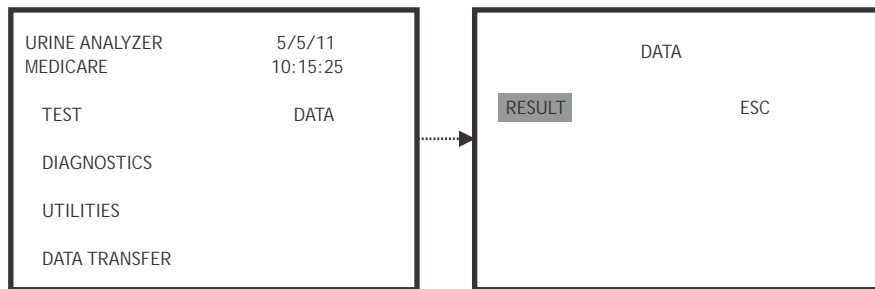

4. PACKING, TRANSPORT AND STORAGE

4.1. General Warnings:

Instrument has to be decontaminated before packing for transportation.

4.2. Packing:

Packaging is needed whenever it is to be transported or shipped by courier or other means.



❖ To pack the instrument follow the instructions as described below:

1. Decontaminate the instrument as explained in chapter No. 12 (Decontamination) of this manual.
2. Place the instrument into the original packaging box; Instrument has to be properly protected by plastic protective material. Put copy of safety clearance certificate (copy of Safety Clearance certificate is attached at the end of this manual)
3. Mark the package with address, instrument identification and warning labels.
- 4.3. Instrument Transportation:
The transportation of the instrument in unpacked condition must be limited within the room where it is used, to avoid damage.
- 4.4. Storage of the Instrument:
Before storing the instrument for a long period, pack it carefully as described above and store indoors.
Relative humidity has to be less than 85%, and temperature between 0°C and 50°C.

5. INSTRUMENT DESCRIPTION

5.1. Perspective View:

A) Front View

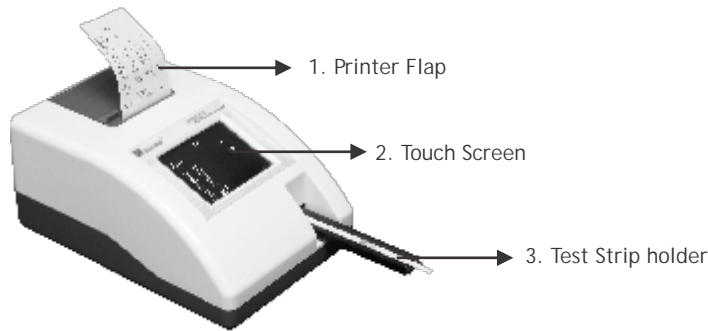

Parts	Function
1. Printer Flap	Opening the printer flap for paper replacement
2. Touch-Screen DISPLAY	Control of equipment functions
3. Test Strip holder	Test strip holder

“ESC” option present on the Utilities screen will help the user to come out of the Utilities screen to the Main menu screen.

8.4. Data Transfer

Select “Data Transfer” option from the Main menu. It will display the data transfer screen which asks the user “Send data via USB?”. Select “Yes” if you want to send the data through USB. If USB cable is not connected then it will display the string “Connect USB cable”. Connect the cable and select ‘Yes’ option present on the Data Transfer screen. Similarly, you can transfer the data through Serial cable.

8.4.1. Data Transfer through USB

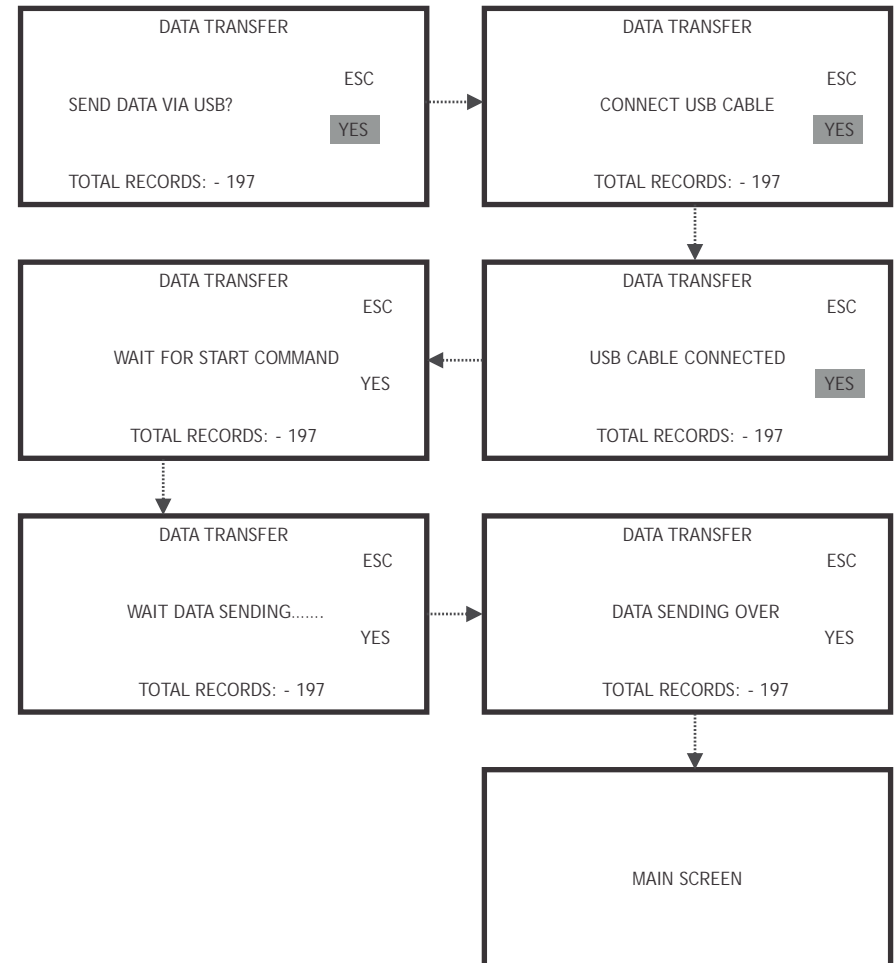

8.3.3. Comm. Mode : USB/Serial
 Communication Mode is a toggle between USB & Serial Communication.

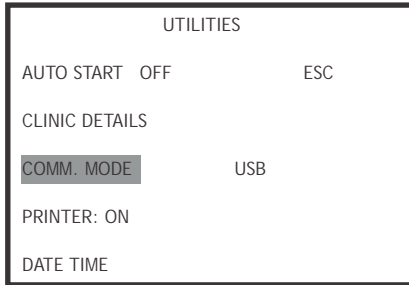

8.3.4. Printer: ON/OFF
 It is a toggle key between "Printer On" & "Printer Off". If user wants to take the print of the result then switch to "Printer On" option or else select "Printer Off".

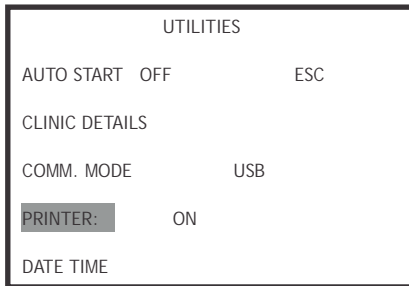

8.3.5. Date Time
 It displays the Date/Time screen where user can enter the Date/Time with the help of numeric screen.

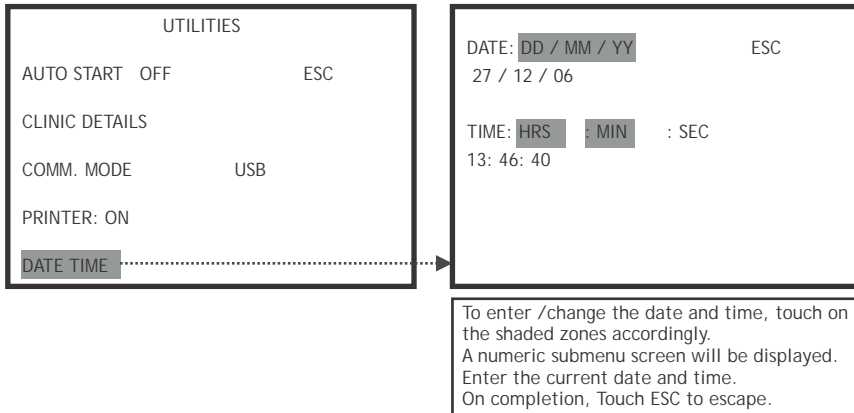

B) Rear View

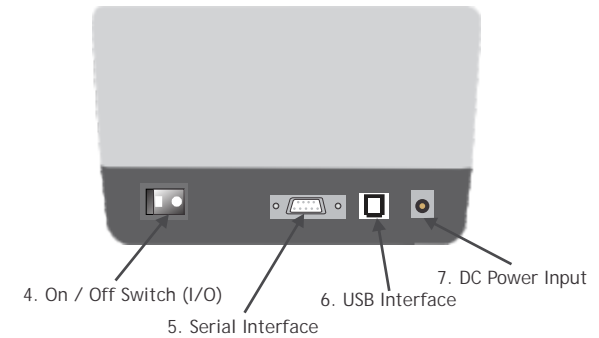

Parts	Function
4. On/Off Switch (I/O)	Turning the equipment on and off
5. Serial Interface	Connection of a computer
6. USB - Interface	Connection of a computer
7. DC Power Input	Contact for the provided Adapter DC voltage

5.2. Instrument Working Principle:

5.2.1. Block Diagram

The diagram representing the main functional elements of the instrument.

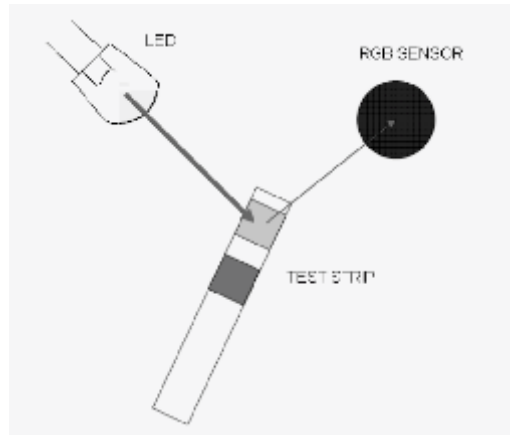

The test stick moves below a fixed measuring head on a slide with an embedded reference pad. The reflectometric analysis of the test stick and the reference field take place during withdrawal and release of the slide. The stick is illuminated with an LED and a detector registers the intensity of light reflected by the test stick at three different wavelengths. Using an internal calibration, the results are calculated from the reflection values. Whenever samples are strongly alkaline, a density correction is automatically conducted.

5.3. Functional Principle:

A measurement is started by placing a strip on the holder. The measurement is started by pressing the LOAD STRIP and READ STRIP on startup screen. The result is shown on the display, printed out and released via the interfaces after the measurement has been completed. All user inputs are performed via the touch-screen.

8.3. Utilities

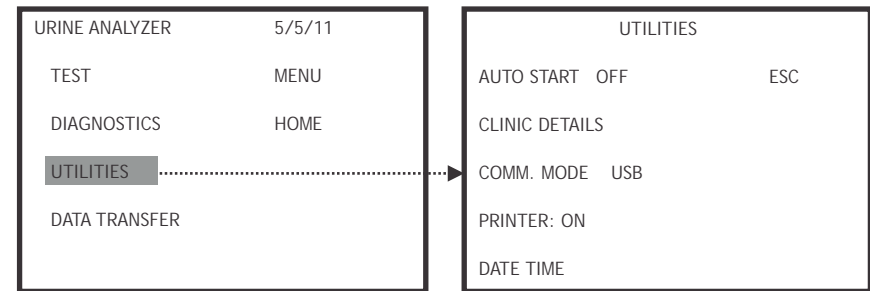

8.3.1. Auto Start (ON/OFF)

It is a toggle key between "Auto Start ON" & "Auto Start OFF". To run the instrument in Auto mode, select "Auto Start ON".

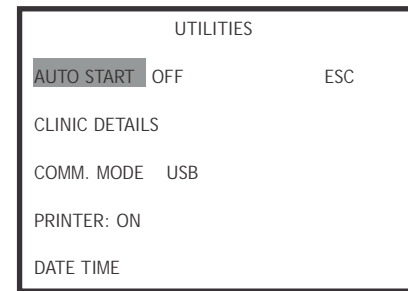

8.3.2. Clinic Details

On selecting "Clinic Details" it will display the alphanumeric screen in order to enter the Clinic Name.

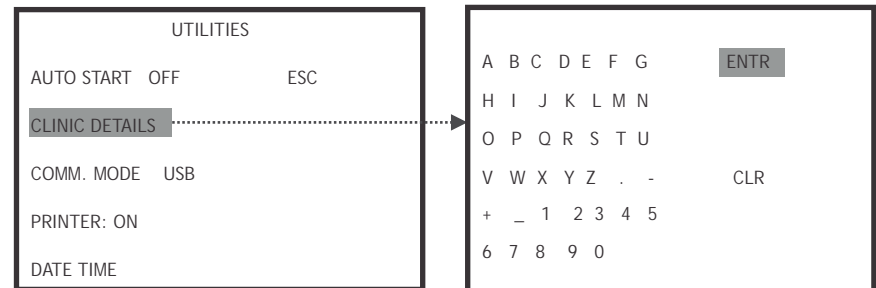

8.2.3. MOTOR TEST

On selecting "Motor Test" it will check whether the motor is moving smoothly or not.

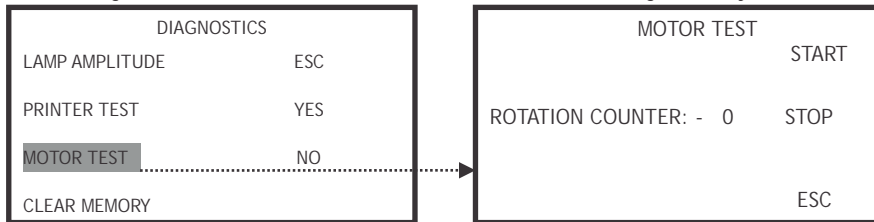

The rotation counter count the cycles of motor movement (in and out position of the strip holder resemble one cycle). To start the counter select "START" option present on the screen. Similarly, select "STOP" option for terminating the process.

8.2.4. Clear Memory

"Clear Memory" helps the user to clear the memory/Results from the RAM. Before clearing the memory it will ask the user whether to clear the memory or not by displaying the message string "Clear Memory Yes/No!". If you want to clear the memory then select "Yes" option present on the DIAGNOSTICS screen, otherwise select "No" option. "Memory not cleared" message string appears if selected 'No' option; whereas "Memory Cleared" message string appears if selected 'Yes' option.

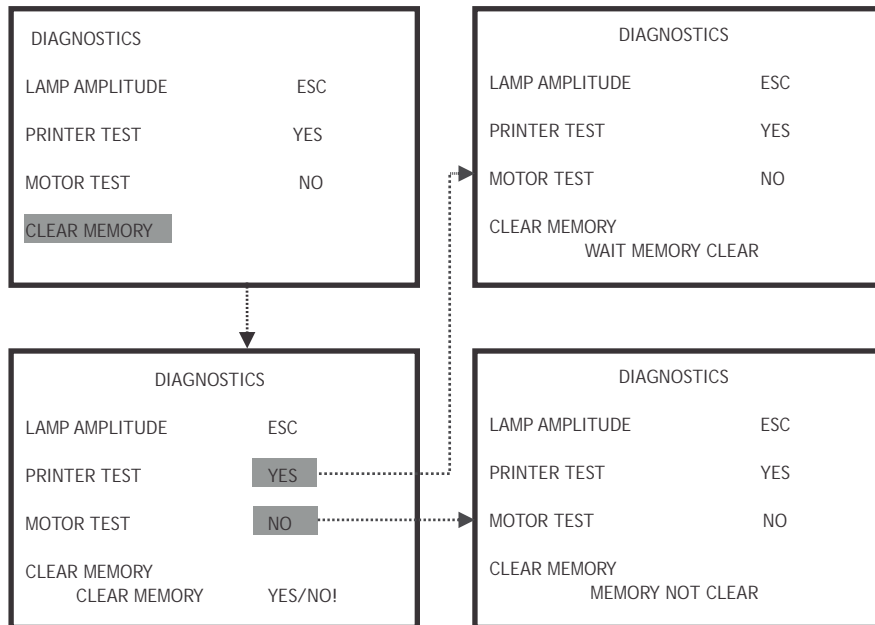

6. INSTALLATION AND START-UP INSTRUCTIONS

6.1. Unpacking Instructions:
Check accessories as per packing list.

6.1.1. Packing List

1. Instrument
2. Adapter with power cord
3. Paper Roll
4. Paper Roll Rod
5. Touch Pen
6. Uricha - 10 Test Strips
7. User Manual



Note: Read the operating manual for URICHA carefully before the first startup in order to ensure an error free operation.

Kindly store all packing materials so as to use it to re-pack and ship for maintenance or servicing.



6.2. Placing the Instrument:

1. The instrument has to be placed on a hard, even surface level bench.
2. Room temperature has to be between 18°C and 35°C with a relative humidity below 85%.
3. Do not place the instrument near strong electromagnetic fields.
4. Do not place the instrument near heating plates, ovens or radiators.
5. Do not expose the instrument to strong light sources (i.e. direct sunlight)
6. Maintain the instrument in a clean, relatively dust free environment to ensure maximum Performance.

6.3. Power Supply

Instrument is directly run on AC-DC switching adaptor.
 Use only recommended adapter. An adapter should be CE marked.
 Earthing Point in adapter is must.

The specifications of AC-DC switching adapter is,
 INPUT: 100 – 240V, 50-60 Hz, 0.5A. (Min)
 OUTPUT: 12V DC, 1.50A. (Min)

Use locally available approved plug in cable /power cord to give the input voltage to Adapter.
 It should be CE, CSA or UL approved.

6.4. Protective Grounding

Warning: Make sure that electrical power source is properly grounded.

6.5. START-UP Instructions:

1. Switch on the instrument.
2. The instrument initializes all the parameters internally, and carries out a power on self-test and then displays the following screen.

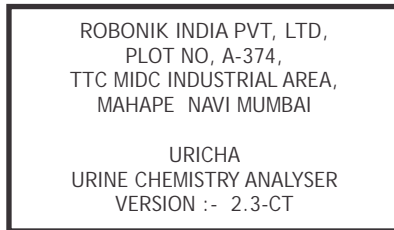

3. If printer is enabled, Model Name will be printed along with Clinic Name, Date & Time.

4. And by default if Printer flap is not closed then it will display the following screen after the initial address screen.



URICHA comes with a built in 20 column Thermal Printer. User has to take proper care to handle this delicate instrument.

TIPS FOR CAREFUL USAGE OF PRINTER



Do not pull the paper when loaded

1. Lift the paper lid carefully and load the paper
2. Keep the instrument clean and dust free

How to insert the paper

Insert the thermal paper roll by placing the sensitive side facing down. The sensitive paper side is recognizable by its smoother face.

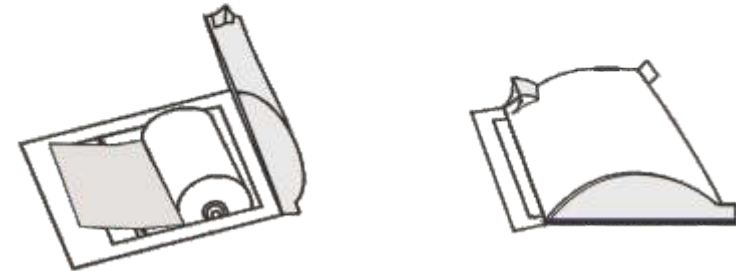

User may operate the instrument by disabling the printer from the utility menu.

If the printer is in its Disabled mode then it will display following screen asking the user whether to enable or disable the printer.

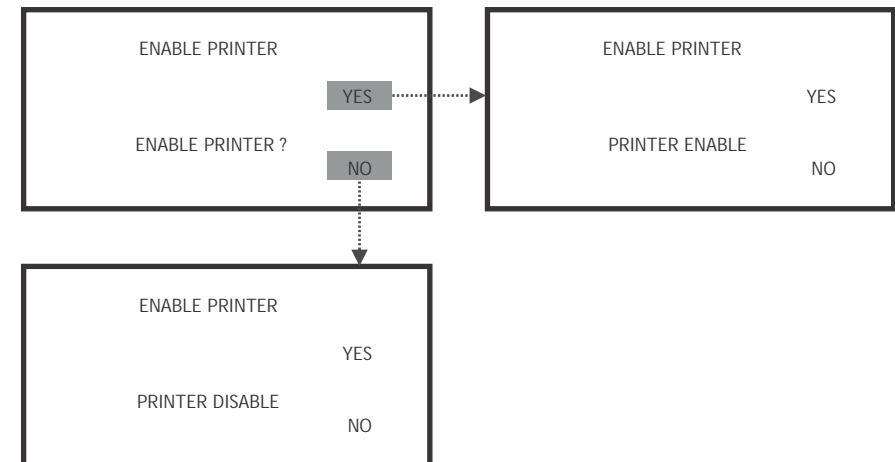

On selecting "Stop Print" option; the printer must stop printing the Lamp Amplitudes. It displays the msg string 'Print Stop' after selecting the "Stop Print" option.

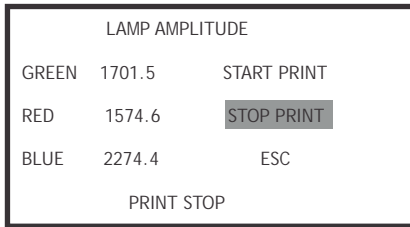

"ESC" option of the Lamp Amplitude screen will help the user to come out of the Lamp Amplitude screen to the DIAGNOSTICS screen.

Remember that if the printer is in its Disabled mode then after selecting START PRINT it must display following screen.

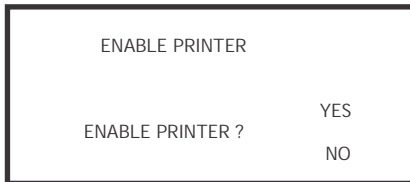

On selecting YES option it will start taking the printout of Lamp Amplitudes; whereas on selecting NO option it will continue with its Disabled mode.

8.2.2. PRINTER TEST

To check the printer, select "Printer Test" option. On selecting "Printer Test"; it will print the Model Name, Version no. & the Clinic Name. And if printer is in disabled mode then it will not print any of the details related to the instrument.

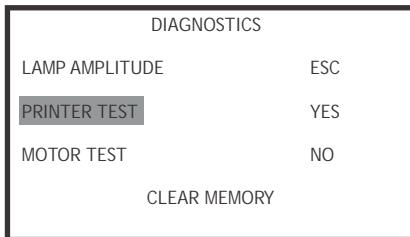

The printout will be displayed as follows:

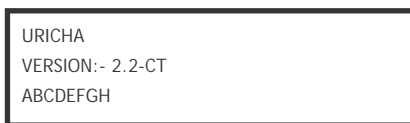

5. And by default if Printer paper is not loaded then it will display the following screen after the initial address screen.

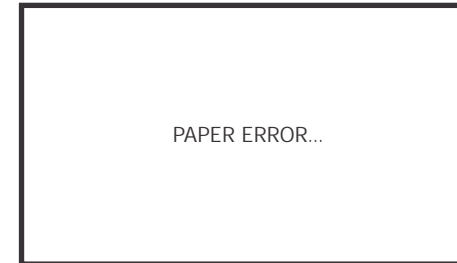

6. START UP Screen appears.

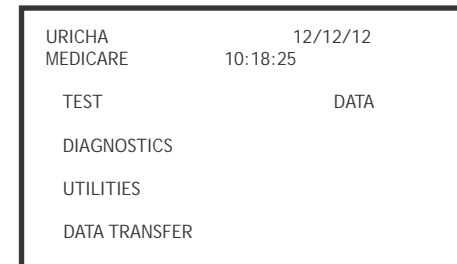

7. START UP screen consists of following menus:

1. TEST
2. DIAGNOSTICS
3. UTILITIES
4. DATA TRANSFER
5. DATA

7. FLOWCHART REPRESENTATION:

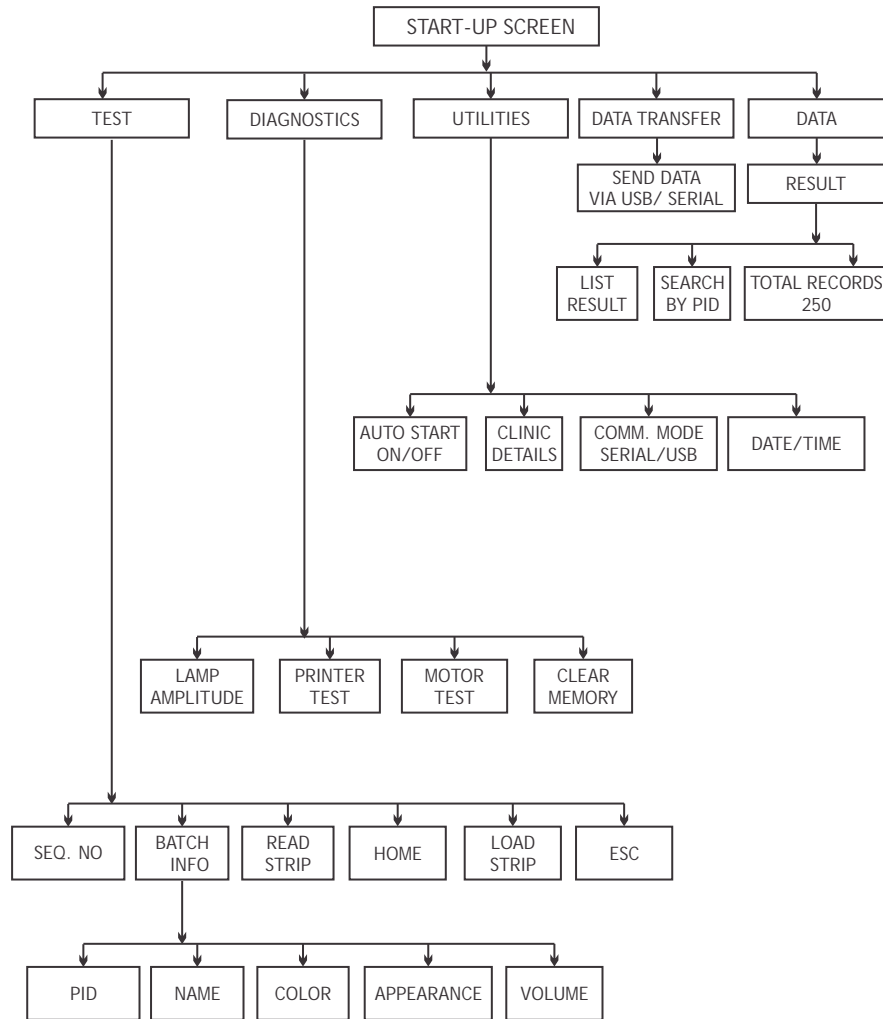

8.2.1. LAMP AMPLITUDE

On selecting "Lamp Amplitude", it will display the following screen.

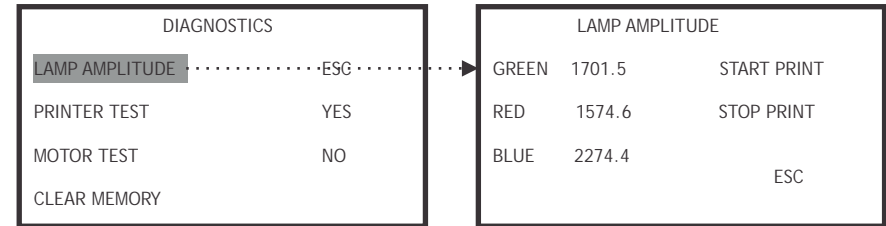

On selecting "Start Print" option; it will print the amplitudes of "Green, Red & Blue" until user selects the "Stop Print" option. When user selects the "Start Print" option it displays the msg string 'Print Start'.

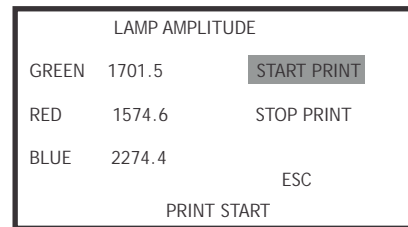

The printout of the Lamp Amplitude:

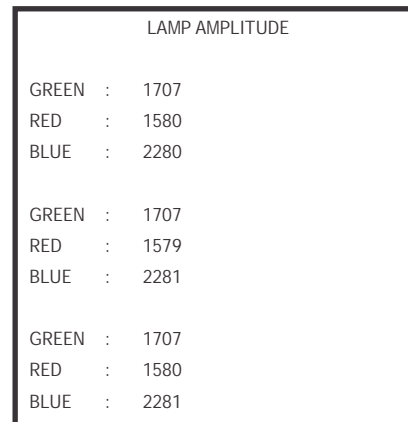

Similarly, "BATCH EMPTY" is displayed when the batch is empty without any sample details.



4. Batch means bunch of samples. And Maximum Samples per batch is 25. User can enter maximum 25 samples in each batch. If you try to add more samples then it will display the message string - "BATCH FULL".

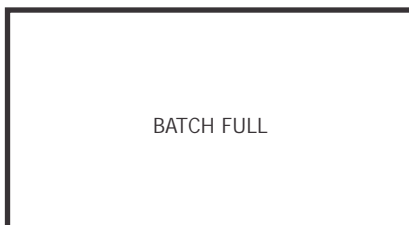

8.2. DIAGNOSTICS

Select DIAGNOSTICS from the Main menu, it will display following screen.

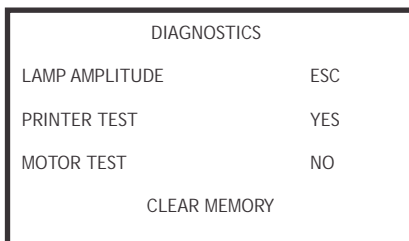

Submenus of screen DIAGNOSTICS are-

- ▶ Lamp Amplitude
- ▶ Printer Test
- ▶ Motor Test
- ▶ Clear Memory

8. START UP SCREEN

8.1. TEST

If selected "Test" from the Main Screen, it will display following screen which consists of SEQ NO., BATCH INFO, Load Strip, & ESC options.

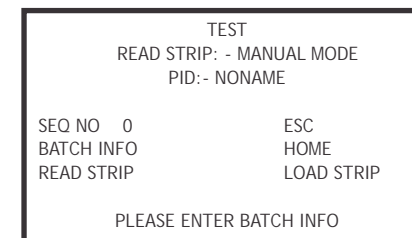
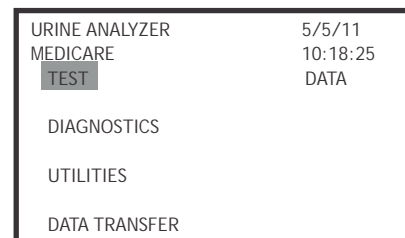

Since it displays the message string - "Please Enter Batch Info", one must first select "BATCH INFO" option present on the screen.

On selecting "BATCH INFO", it will display following sub-screen through which user can enter the PID, Name (Patient Name), Color, Appearance and Volume of the sample.

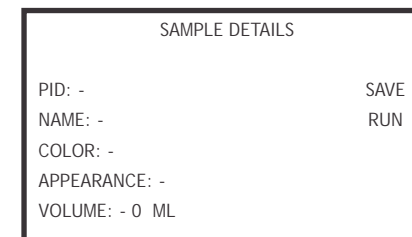
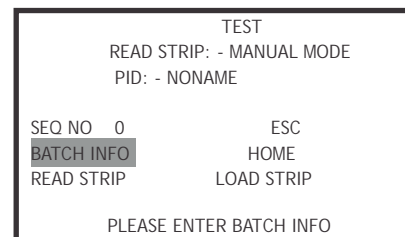

Select PID option from the Sample Details screen. It helps the user for the identity of the patient by providing the alphanumeric screen.

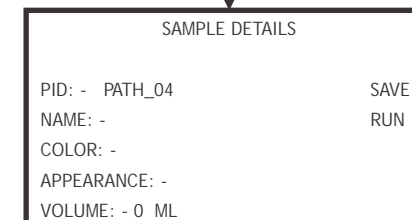
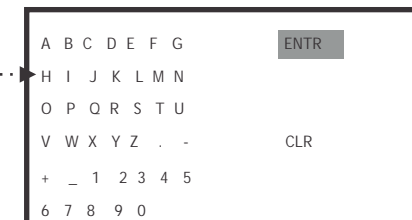
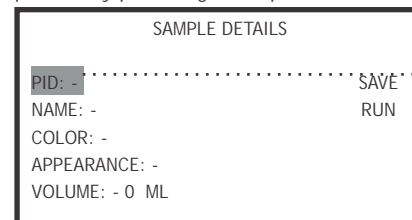

Similarly, on selecting "NAME", it will display Alpha-numeric screen where user must enter the Patient's Name.

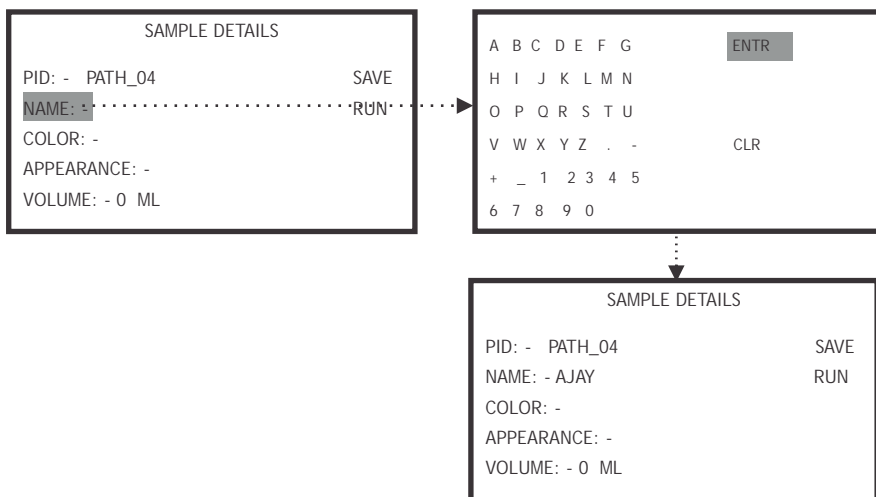

The next parameter helps to specify the color of the sample. These colors can vary from sample to sample.

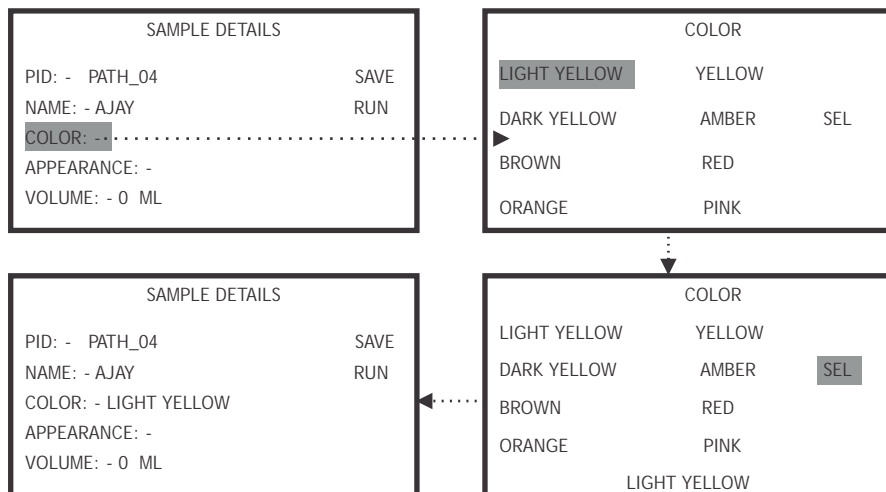

Since, it displays the message string - "REMOVE STRIP", one has to remove the previous strip and then load new strip. Now it is ready to take the readings for the next sample. Continue the running process as mentioned above -

By default the Test Result is saved which cannot be deleted. It can be erased through "Clear Memory" option present in the DIAGNOSTICS screen.

Note: 1. Remember that if you change the setting of "AUTO START" in Utilities, for instance if you set "AUTO START -ON", then instrument will start in its Auto mode and will display the Test screen as follows-

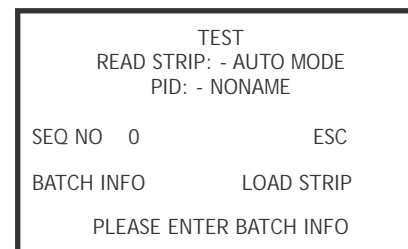

2. If storage capacity is full then after selecting Test option from the main menu it will display the message "MEMORY FULL, RECORDS IN SEQ. DELETE" at the bottom of the Test screen.

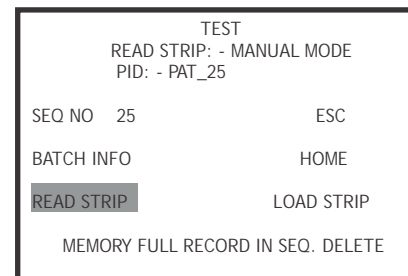

3. Suppose after entering all the Sample Details, if user select "RUN" option without saving the parameters, then it will display the message string - "Please Save Sample Details" as shown below -

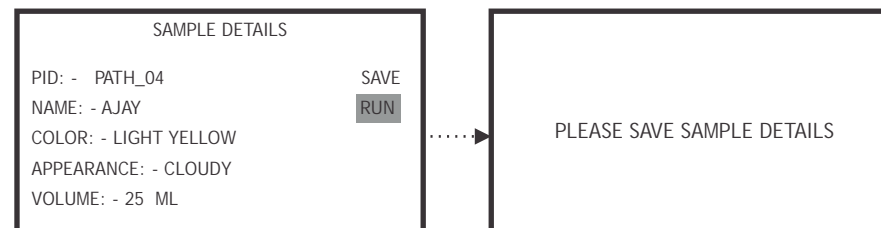

After reading the strip, the strip holder move to the load position and the result is displayed on the screen as shown below-

```

RESULT
12/12/12      10:42:25
SEQ NO 1
PID PATH_01
BLD NEG
UBG NORM
BIL NEG
PRO NEG
*NIT POS      +
KET NEG
*GLU TRACE
PH 5
SG 1.030
LEU NEG
    
```

User can take the print of the displayed Result by selecting "PRINT" option present on the screen.

```

RESULT
12/12/12      10:42:25
SEQ NO 1
PID PATH_01
BLD NEG
UBG NORM
BIL NEG
PRO NEG
*NIT POS      +
KET NEG
*GLU TRACE
PH 5
SG 1.030
LEU NEG
    
```

```

-----
RESULT
URICHA - 10
-----
12/12/12      10:42:25
SEQ NO: 1
PID: PATH_01
NAME: AJAY
COLOR: LIGHT YELLOW
APPEARANCE: CLOUDY
*****
BLD NEG
UBG NORM
BIL NEG
PRO NEG
*NIT POS      +
KET NEG
*GLU TRACE
PH 5
SG 1.030
LEU NEG
-----
    
```

After selecting ESC option, it will display following screen where next sample is ready to take its readings.

```

RESULT
12/12/12      10:42:25
SEQ NO 1
PID PATH_01
BLD NEG
UBG NORM
BIL NEG
PRO NEG
*NIT POS      +
KET NEG
*GLU TRACE
PH 5
SG 1.030
LEU NEG
    
```

```

TEST
READ STRIP: - MANUAL MODE
PID: - PATH_02

SEQ NO 2      ESC
BATCH INFO    HOME
READ STRIP    LOAD STRIP
REMOVE STRIP
    
```

Similarly, select the Appearance of the particular sample.

```

SAMPLE DETAILS
PID: - PATH_04      SAVE
NAME: - AJAY        RUN
COLOR: -
APPEARANCE: -
VOLUME: - 0 ML
    
```

```

APPEARANCE
CLEAR      HAZY      SEL
CLOUDY     TURBID
MILKY
    
```

```

SAMPLE DETAILS
PID: - PATH_04      SAVE
NAME: - AJAY        RUN
COLOR: - LIGHT YELLOW
APPEARANCE: - CLOUDY
VOLUME: - 0 ML
    
```

```

APPEARANCE
CLEAR      HAZY      SEL
CLOUDY     TURBID
MILKY      CLOUDY
    
```

Enter "VOLUME" of the Sample in mL (milliliters)

```

SAMPLE DETAILS
PID: - PATH_04      SAVE
NAME: - AJAY        RUN
COLOR: - LIGHT YELLOW
APPEARANCE: - CLOUDY
VOLUME: - 0 ML
    
```

```

Numeric Values: 25
1 2 3 4 5 6      ENTR
7 8 9 0 .      CLR
    
```

```

SAMPLE DETAILS
PID: - PATH_04      SAVE
NAME: - AJAY        RUN
COLOR: - LIGHT YELLOW
APPEARANCE: - CLOUDY
VOLUME: - 25 ML
    
```

User can enter max. 250 ml of volume

Note: - Limit Set for the Test Parameters -

Parameter	Values (Limits)
PID	Upto 15 characters
Name	Upto 15 characters
Volume	Upto 250 ML (milliliters)
Samples Per Batch	25 samples
Motor Rotation	65000 rotations

After entering all the test parameters, select "SAVE" option present on the screen. On selecting this option it will display following sub-screens.

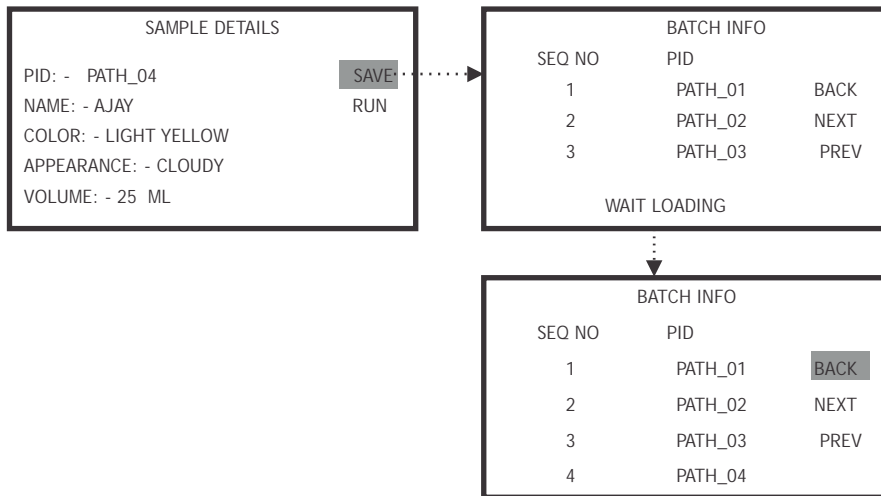

Select "Back" to go back to the Sample Details screen. Whereas, "NEXT" & "PREV" options are used for the browsing purpose. Remember in a single batch one can enter maximum 25 Sample Details.

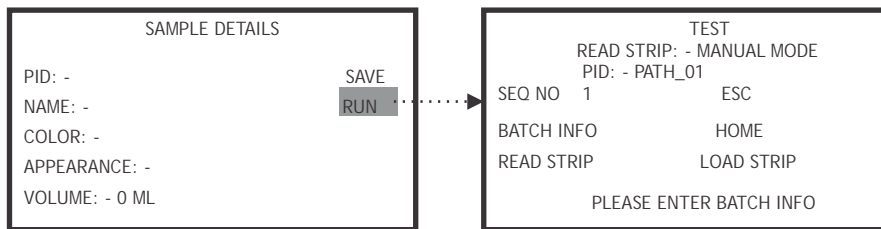

When we select Test option, by default the strip holder is already in the load position. Now dip a test stick into the urine sample for approx. one second. Hold by touching the edge of the strip to a paper towel to remove excess sample. Slide or push the strip to the end of the strip holder. Do not touch the reagent Pads on the test strip.

